



H BUMPER

All Makes Catalog
Popular Part Numbers

WELCOME

TO THE HENDRICKSON ALL MAKES BUMPER PROGRAM

Hendrickson is the leading tier one OEM supplier of heavy-duty truck bumpers for the North American commercial vehicle industry. Our commitment to quality and product innovation drives this industry leadership position, thus promoting the development of products that enhance vehicle styling and durability. Key capabilities, which include proprietary bumper forming technology and advanced metal and plastic materials, enable Hendrickson to manufacture aerodynamically contoured bumper designs that are durable yet lightweight.

Hendrickson has an extensive field sales, parts and service organization to support our customers around the globe — truck owners, dealers, fleets and OEMs. Our investment in new technologies will continue as we strive to deliver value to our customers. At Hendrickson, innovation never rests.

TABLE OF CONTENTS

| | |
|--|----|
| Bumper Materials and Technology | 1 |
| Understanding the Hendrickson All Makes Bumper Program | 2 |
| Ford | 3 |
| Freightliner | 4 |
| International | 10 |
| Kenworth | 17 |
| Mack | 22 |
| Peterbilt | 26 |
| Volvo | 31 |
| Western Star | 34 |
| Genuine Hendrickson - All Makes Program | 37 |

BUMPER

PRODUCTS AND TECHNOLOGY



AERO CLAD® Stainless Steel Clad Aluminum

- Durable, bright mirrored finish
- Finish 10 times thicker than chrome
- Resists corrosion
- Resists cracking, pitting, peeling and fading
- Up to 50 percent lighter than steel options
- Tested fuel efficient design
- Minor abrasions can be buffed
- Full five-year limited warranty*



Steel Chrome

- One-year limited warranty*
- Available in 7-gauge or 10-gauge steel
- Bright mirrored finish
- Many shapes available
- Customize your bumper with cutouts and road lights
- Also available in corrosion resistant E-coat finish, ready for top coat

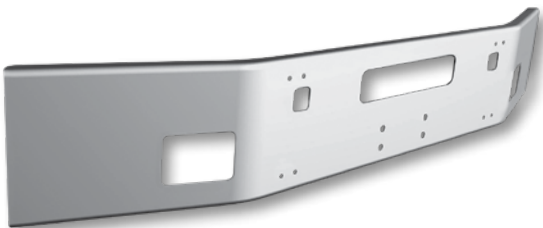

Solid Stainless Steel

- Full five-year limited warranty*
- Bright mirrored finish
- Resists corrosion
- Resists cracks, peeling, rust and fading
- As durable as a steel bumper
- Minor abrasions can be buffed

* Visit our website at www.hendricksonbumper.com or call 800.356.6737 for complete warranty terms, conditions and limitations.



OVERVIEW

HENDRICKSON ALL MAKES BUMPER PROGRAM

PART NUMBERING SYSTEM

Part Type:

- 100 - 199 Ford
- 200 - 299 Freightliner
- 400 - 499 International
- 500 - 599 Kenworth
- 600 - 699 Mack
- 700 - 799 Blank
- 800 - 899 Peterbilt
- 900 - 903 Volvo
- 904 - 911 Western Star

Material Thickness:

- 0 = Ten Gauge Steel
- 7 = Seven Gauge Steel

Material Abbreviations:

- SQ = Texas Square
- SSC = Stainless Steel Clad Aluminum
- SSCSQ = Stainless Steel Clad Aluminum
Texas Square
- STQ = Solid Stainless Steel Texas Square
- BRT = HENDRICKSON AERO BRIGHT®

Example: Part #0100SQ

- 0 = Ten gauge steel
- 100 = Ford
- SQ = Texas Square

Exclusive: Available only through OEM Truck Dealer

ORDER / REORDER REQUIREMENTS

Direct Questions to Hendrickson
Customer Service at **1-800-356-6737**,
or OEM Customer Service Department.

FREIGHT POLICY

Direct Questions to Hendrickson
Customer Service at **1-800-356-6737**,
or OEM Customer Service Department.

INQUIRIES

Questions regarding literature, order status and product
information may be directed to Hendrickson Customer
Service at **1-800-356-6737**, or OEM Customer Service
Department.

WARRANTY AND RETURN POLICY

AERO CLAD®: Five years or 500,000 miles from date of
sale. Direct questions to your OEM claims administrator.

Steel Chrome: One year or 100,000 miles from date of
sale for materials and workmanship. Direct questions to
your OEM claims administrator.

Solid Stainless Steel: Five years or 500,000 from
date of sale. Direct questions to your OEM claims
administrator.

LN / LT / LTN / L8000 / 9000

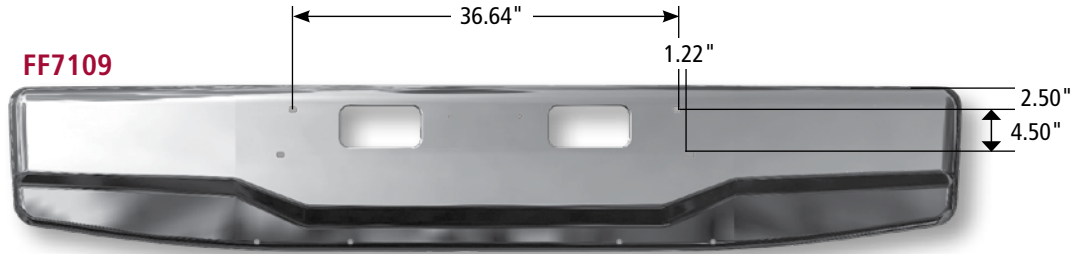

Ford OEM L-Series 8000 and 9000

| PART NO. | MATERIAL / FINISH | GAUGE / THICKNESS | STYLE | LIGHT | CENTER STEP | VENT | TOW | RADAR | EXCLUSIVE | YEAR | MOUNT / BRACKET |
|---------------|-------------------|-------------------|-----------|-------|-------------|------|-----|-------|-----------|-----------|-----------------|
| FF7109 | Chrome | 7Ga | 16" Taper | N | N | N | Y | N | Y | '88 - '96 | N |

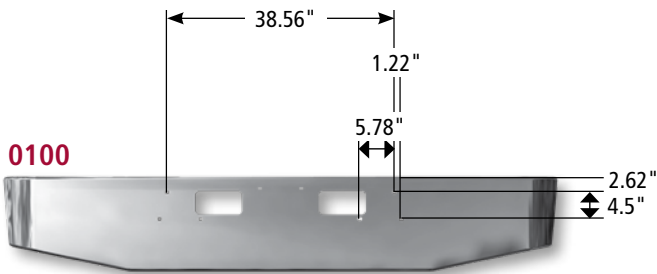

Ford L-Series conventional fits LN-LT-LTN 800, 900, 8000 and 9000 (Tow holes only). Fits trucks with 6V92 Detroit engine or 300 Cummins engine 1988 or newer (Axle forward only).

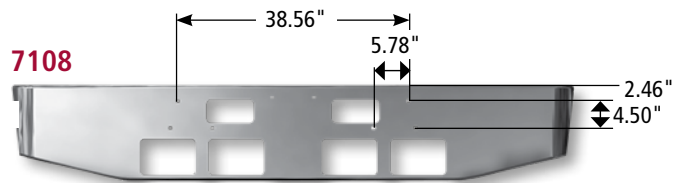

Ford Conventional LTL 9000 — Tow holes and four square light holes.

| PART NO. | MATERIAL / FINISH | GAUGE / THICKNESS | STYLE | LIGHT | CENTER STEP | VENT | TOW | RADAR | EXCLUSIVE | YEAR | MOUNT / BRACKET |
|-------------|-------------------|-------------------|-----------|-------------|-------------|------|-----|-------|-----------|-----------|-----------------|
| 0100 | Chrome | 10Ga | 16" Taper | N | N | N | Y | N | N | '88 - '96 | N |
| 7100 | Chrome | 8Ga | 16" Taper | N | N | N | Y | N | N | '88 - '96 | N |
| 7108 | Chrome | 8Ga | 16" Taper | 4 Rectangle | N | N | Y | N | N | '88 - '96 | N |

FREIGHTLINER

FLC 112

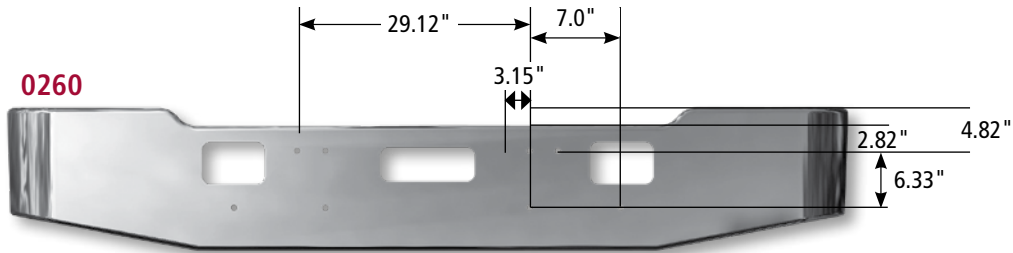

Freightliner FLC-112

| PART NO. | MATERIAL / FINISH | GAUGE / THICKNESS | STYLE | LIGHT | CENTER STEP | VENT | TOW | RADAR | EXCLUSIVE | YEAR | MOUNT / BRACKET |
|-------------|-------------------|-------------------|--------------|-------------|-------------|------|-----|-------|-----------|-------------|-----------------|
| 0260 | Chrome | 10Ga | 16" Gullwing | N | Y | Y | Y | N | N | '86 - Newer | N |
| 0261 | Chrome | 10Ga | 16" Gullwing | 2 Rectangle | Y | Y | Y | N | N | '86 - Newer | N |

FLD 112 / FLD 120 / FLD 120 SEVERE DUTY



Freightliner FLD 112 (SD), FLD 120

| PART NO. | MATERIAL / FINISH | GAUGE / THICKNESS | STYLE | LIGHT | CENTER STEP | VENT | TOW | RADAR | EXCLUSIVE | YEAR | MOUNT / BRACKET |
|-------------|-------------------|-------------------|-----------------|-------------|-------------|------|-----|-------|-----------|-----------|-----------------|
| 0232 | Chrome | 10Ga | 12" Set Back | 2 Rectangle | Y | N | Y | N | N | '92 - '07 | N |
| 7233 | Chrome | 7Ga | 12" Set Forward | 2 Rectangle | Y | N | Y | N | N | '92 - '07 | N |

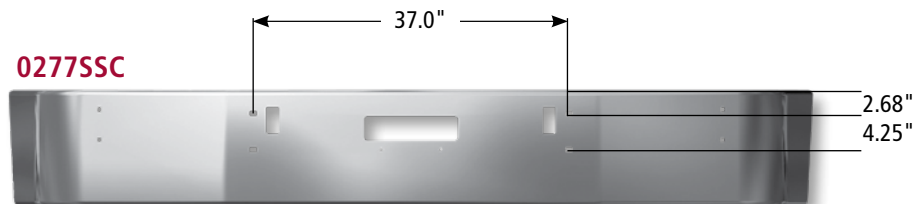

Freightliner FLD 112

| PART NO. | MATERIAL / FINISH | GAUGE / THICKNESS | STYLE | LIGHT | CENTER STEP | VENT | TOW | RADAR | EXCLUSIVE | YEAR | MOUNT / BRACKET |
|-----------------|-------------------|-------------------|----------------|-------------|-------------|------|-----|-------|-----------|-----------|-----------------|
| 0277SSC* | AERO CLAD® | 0.125" | 13.5" Set Back | N | Y | N | Y | N | N | '89 - '04 | N |
| 0278SSC* | AERO CLAD | 0.125" | 13.5" Set Back | 2 Rectangle | Y | N | Y | N | N | '89 - '04 | N |

*Braces and spacers included with bumper.

For models fitted with Perlex drive lights, use Freightliner back-up bar P/N A21-20133-003.

For models fitted with Marchel drive lights, use Freightliner back-up bar P/N A21-20133-000.



FLD 112 / FLD 120 / FLD 120 SEVERE DUTY cont.

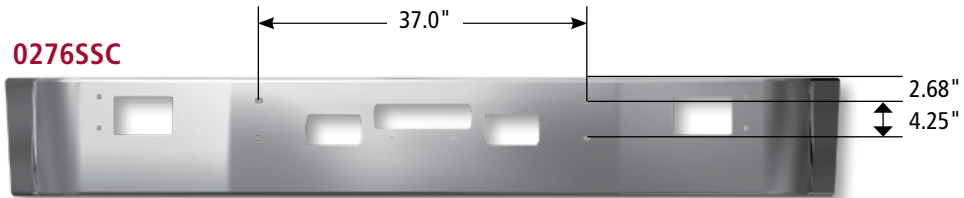

Freightliner FLD 120

| PART NO. | MATERIAL / FINISH | GAUGE / THICKNESS | STYLE | LIGHT | CENTER STEP | VENT | TOW | RADAR | EXCLUSIVE | YEAR | MOUNT / BRACKET |
|-----------------|-------------------|-------------------|----------------|-------------|-------------|------|-----|-------|-----------|-----------|-----------------|
| 0275SSC* | AERO CLAD® | 0.125" | 13.5" Set Back | N | Y | N | Y | N | N | '00 - '07 | Y |
| 0276BX | Steel Primed | 10Ga | 13.5" Set Back | 2 Rectangle | Y | N | Y | N | N | '00 - '07 | Y |
| 0276SSC* | AERO CLAD | 0.125" | 13.5" Set Back | 2 Rectangle | Y | N | Y | N | N | '00 - '07 | Y |
| 0279BX | Steel Primed | 10Ga | 13.5" Set Back | N | Y | N | N | N | N | '00 - '07 | Y |
| 0279SSC* | AERO CLAD | 0.125" | 13.5" Set Back | N | Y | N | N | N | N | '00 - '07 | Y |

*Braces and spacers included with bumper.

For models fitted with Perlex drive lights, use Freightliner back-up bar P/N A21-20133-003.

For models fitted with Marchel drive lights, use Freightliner back-up bar P/N A21-20133-000.

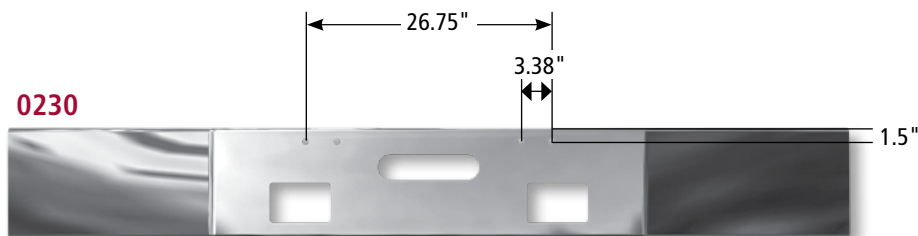

Fits FLD 120 Severe Duty

| PART NO. | MATERIAL / FINISH | GAUGE / THICKNESS | STYLE | LIGHT | CENTER STEP | VENT | TOW | RADAR | EXCLUSIVE | YEAR | MOUNT / BRACKET |
|-------------|-------------------|-------------------|------------------|-------------|-------------|------|-----|-------|-----------|-----------|-----------------|
| 0230 | Chrome | 10Ga | 12" Set Back | 2 Rectangle | Y | N | N | N | N | '86 - '08 | N |
| 7230 | Chrome | 7Ga | 12" Set Back | 2 Rectangle | Y | N | N | N | N | '86 - '08 | N |
| 7240 | Chrome | 7Ga | 12" Texas Square | 2 Rectangle | Y | N | Y | N | N | '86 - '09 | N |

FREIGHTLINER

FLD-CLASSIC

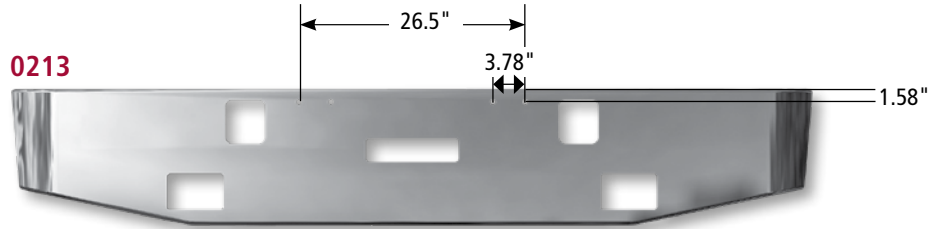

| PART NO. | MATERIAL / FINISH | GAUGE / THICKNESS | STYLE | LIGHT | CENTER STEP | VENT | TOW | RADAR | EXCLUSIVE | YEAR | MOUNT / BRACKET |
|------------------|-------------------|-------------------|------------------|-------------|-------------|------|-----|-------|-----------|-----------|-----------------|
| 0207 | Chrome | 10Ga | 16" Taper | N | N | N | Y | N | N | '84 - '02 | N |
| 0207SQ | Chrome | 10Ga | 18" Texas Square | N | Y | N | Y | N | N | '84 - '02 | N |
| 0209 | Chrome | 10Ga | 16" Taper | Y | N | N | N | N | N | '02 - '07 | N |
| 0209NL | Chrome | 10Ga | 16" Taper | N | N | N | N | N | N | '02 - '07 | N |
| 0209NLSQ | Chrome | 10Ga | 18" Texas Square | N | N | N | N | N | N | '84 - '02 | N |
| 0213 | Chrome | 10Ga | 16" Taper | 2 Rectangle | N | N | Y | N | N | '02 - '07 | N |
| 0213SQ | Chrome | 10Ga | 18" Texas Square | 2 Rectangle | N | N | Y | N | N | '02 - '07 | N |
| 0213SSCSQ | AERO CLAD® | 0.125" | 18" Texas Square | 2 Rectangle | N | N | Y | N | N | '02 - '07 | N |
| 0223SQ | Chrome | 10Ga | 18" Texas Square | N | N | N | N | N | N | '84 - '02 | N |
| 0267SQ12 | Chrome | 10Ga | 12" Texas Square | N | N | N | N | N | N | '84 - '08 | N |
| 0283SQ18 | Chrome | 10Ga | 18" Box | N | Y | N | N | N | N | '84 - '06 | N |
| 7209 | Chrome | 8Ga | 16" Taper | 2 Rectangle | N | N | N | N | N | '84 - '02 | N |
| 7209NL | Chrome | 8Ga | 16" Taper Square | N | N | N | N | N | N | '84 - '02 | N |
| 7209NLSQ | Chrome | 8Ga | 18" Texas Square | N | N | N | N | N | N | '84 - '02 | N |
| 7213SQ | Chrome | 8Ga | 18" Texas Square | 2 Rectangle | N | N | Y | N | N | '02 - '07 | N |
| 7213SQ12 | Chrome | 8Ga | 12" Texas Square | 2 Rectangle | Y | N | Y | N | N | '02 - '07 | N |
| 7250SSC | AERO CLAD | 0.160" | 16" Taper | 2 Rectangle | N | N | N | N | N | '84 - '03 | N |
| 7251SSC | AERO CLAD | 0.160" | 16" Taper | N | N | N | N | N | N | '98 - '10 | N |

FREIGHTLINER



FLD-CLASSIC cont.

| PART NO. | MATERIAL / FINISH | GAUGE / THICKNESS | STYLE | LIGHT | CENTER STEP | VENT | TOW | RADAR | EXCLUSIVE | YEAR | MOUNT / BRACKET |
|------------------|-------------------|-------------------|------------------|-------------|-------------|------|-----|-------|-----------|-----------|-----------------|
| 7213SSC | AERO CLAD® | 0.160" | 16" Taper | 2 Rectangle | N | N | Y | N | N | '02 - '10 | N |
| 0216 | Chrome | 10Ga | 16" Taper | N | N | N | Y | N | N | '02 - '10 | N |
| 0216SSCSQ | AERO CLAD | 0.125" | 18" Texas Square | N | N | N | Y | N | N | '02 - '10 | N |
| 7216 | Chrome | 8Ga | 16" Taper | N | N | N | Y | N | N | '02 - '10 | N |
| 7216SQ | Chrome | 8Ga | 18" Texas Square | N | N | N | Y | N | N | '02 - '10 | N |
| 7216SSC | AERO CLAD | 0.160" | 16" Taper | N | N | N | Y | N | N | '02 - '10 | N |

122SD

| PART NO. | MATERIAL / FINISH | GAUGE / THICKNESS | STYLE | LIGHT | CENTER STEP | VENT | TOW | RADAR | EXCLUSIVE | YEAR | MOUNT / BRACKET |
|------------------|-------------------|-------------------|-----------------|-------|-------------|------|-----|-------|-----------|-------------|-----------------|
| 7299SSC | AERO CLAD | 0.160" | 12" Set Forward | Y | N | N | Y | N | N | '13 - Newer | N |
| 7299NLSSC | AERO CLAD | 0.160" | 12" Set Forward | N | N | N | Y | N | N | '13 - Newer | N |



FREIGHTLINER

BUSINESS CLASS

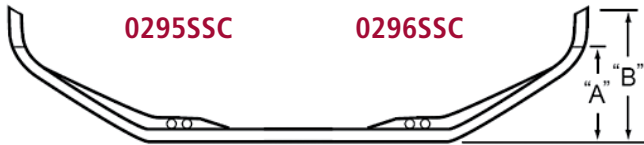

| PART NO. | MODEL | LEG | DIMENSION |
|----------|-----------------------|-----|-----------|
| 0296SSC | FL50, 60, 70, 80, 106 | A | 14.2" |
| 0295SSC | FL50, 60, 70, 80, 106 | B | 19.9" |



Freightliner stainless steel clad aluminum fits Business Class — Includes brackets (Installed)

| PART NO. | MATERIAL / FINISH | GAUGE / THICKNESS | STYLE | LIGHT | CENTER STEP | VENT | TOW | RADAR | EXCLUSIVE | YEAR | MOUNT / BRACKET |
|----------|-------------------|-------------------|--------------|-------------|-------------|------|-----|-------|-----------|-----------|-----------------|
| 0295SSC | AERO CLAD® | 0.125" | 11" Set Back | 2 Rectangle | Y | N | N | N | N | '97 - '04 | N |
| 0296SSC | AERO CLAD | 0.125" | 11" Set Back | 2 Rectangle | Y | N | N | N | N | '97 - '04 | N |

CENTURY CLASS

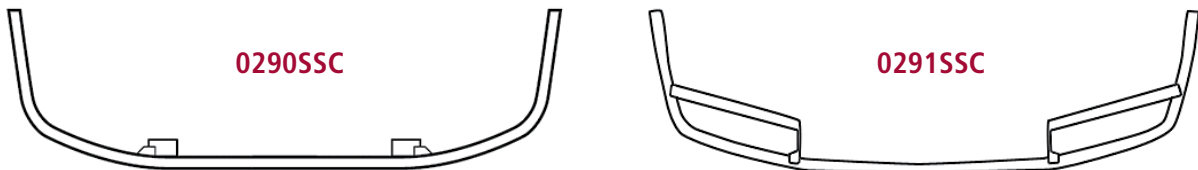

Freightliner Century Class stainless steel clad aluminum — Includes brackets (Installed)*

| PART NO. | MATERIAL / FINISH | GAUGE / THICKNESS | STYLE | LIGHT | CENTER STEP | VENT | TOW | RADAR | EXCLUSIVE | YEAR | MOUNT / BRACKET |
|----------|-------------------|-------------------|----------------|-------|-------------|------|-----|-------|-----------|-----------|-----------------|
| 0290SSC* | AERO CLAD | 0.125" | 14.5" Set Back | N | Y | N | Y | N | N | '96 - '03 | Y |
| 0291SSC | AERO CLAD | 0.125" | 14.5" Set Back | N | Y | N | Y | N | N | '04 - '07 | Y |

*OEM Required hardware to install bumper on '96 truck model (only):

Mounting bracket (P/N: A21-25693-000 LH & A21-25693-001 RH) and spacer (2 required, P/N: 23-11427-038) available from your Freightliner dealer. Drill 14mm hole in top mounting bracket for pre-1997 Century Class.

FREIGHTLINER

COLUMBIA

Columbia three-piece bumper now available with a ready-to-paint e-coat finish.



0292R

FF0292C

0292L



Features and Benefits

- Easy installation to factory mounts
- High-impact TPO resin end caps
- E-coat finish
- Ready for top coat
- Sturdy and robust
- One-year limited warranty*



Freightliner Columbia stainless steel clad aluminum

| PART NO. | LEG | DIMENSION |
|-----------|-----|-----------|
| 0292SSC* | A | 25.15" |
| 0293SSC** | B | 28.34" |

* When replacing factory bumper you must refer to Freightliner Bill of Material T80133.

** When replacing factory bumper you must refer to Freightliner Bill of Material T80132.

| PART NO. | MATERIAL / FINISH | GAUGE / THICKNESS | STYLE | LIGHT | CENTER STEP | VENT | TOW | RADAR | EXCLUSIVE | YEAR | MOUNT / BRACKET |
|----------|-------------------|-------------------|----------------------|---------|-------------|------|-----|-------|-----------|--------------|-----------------|
| 0292SSC | AERO CLAD® | 0.125" | 14.5" Set Back | N | Y | N | Y | N | N | '04-'07 | N |
| 0293SSC | AERO CLAD | 0.125" | 14.5" Set Back | N | Y | N | Y | N | N | Prior to '04 | N |
| FF0292CX | Steel Primed | 0.09" | Metal Center Section | 2 Round | N | Y | N | N | Y | '04-'07 | N |



INTERNATIONAL

PROSTAR

H AERO CLAD® Stainless Steel Clad Aluminum Bumper

Features and Benefits

- Durable, bright mirrored finish
- Finish 10 times thicker than chrome
- Resists corrosion
- Resists cracking, pitting, peeling and fading
- High ground clearance
- Tested fuel efficient design
- Minor abrasions can be buffed
- Includes rock screens
- Includes plastic top fillers
- Full five-year limited warranty*



| PART NO. | MATERIAL / FINISH | GAUGE / THICKNESS | LIGHT | CENTER STEP | VENT | TOW | RADAR | YEAR | MOUNT | BRACKET |
|-------------|----------------------|-------------------|-------|-------------|------|-----|-------|------------------|-------------|-------------------|
| AM0449SSC | AERO CLAD® | 0.125" | Y | N | Y | Y | N | '09 - Older | Tilt Mount | Brackets Included |
| AM0450SSC | AERO CLAD | 0.125" | Y | N | Y | Y | N | '10 - Newer | Fixed Mount | None |
| AM0451SSC | AERO CLAD | 0.125" | Y | N | Y | Y | N | All | Tilt Mount | None |
| AM0460SSCAK | AERO CLAD | 0.125" | Y | N | Y | Y | N | Feb. '15 - Newer | Fixed Mount | Brackets Included |
| AM0460BKTK | Bracket Mounting Kit | | | | | | | Feb. '15 - Newer | Fixed Mount | Brackets Only |

NOTE: All bumpers are exclusive. Converting OEM Fixed Mount Bumper with AM0451SSC will require two additional brackets through OEM.



INTERNATIONAL

LT

H AERO CLAD®
Stainless Steel Clad
Aluminum Bumper

Features and Benefits

- Durable, bright mirrored finish
- Finish 10 times thicker than chrome
- Resists corrosion
- Resists cracking, pitting, peeling and fading
- High ground clearance
- Tested fuel efficient design
- Minor abrasions can be buffed
- Includes rock screens
- Includes plastic top fillers
- Full five-year limited warranty*



| PART NO. | MATERIAL / FINISH | GAUGE / THICKNESS | LIGHT | CENTER STEP | VENT | TOW | RADAR | YEAR | MOUNT | BRACKET |
|-------------------|----------------------|-------------------|-------|-------------|------|-----|-------|------------------|-------------|---------------|
| AM0453SSC | AERO CLAD® | 0.125" | Y | N | Y | Y | N | '10 - Newer | Fixed Mount | None |
| AM0460BKTK | Bracket Mounting Kit | | | | | | | Feb. '15 - Newer | Fixed Mount | Brackets Only |

NOTE: All bumpers are exclusive. Converting OEM Fixed Mount Bumper with AM0451SSC will require two additional brackets through OEM.



INTERNATIONAL

LONESTAR

Features and Benefits

- Durable, bright mirrored finish
- Finish 10 times thicker than chrome
- Resists corrosion
- Resists cracking, pitting, peeling and fading
- Lightweight for better fuel economy
- Minor abrasions can be buffed
- Full 5-year limited warranty*



| PART NO. | MATERIAL / FINISH | GAUGE / THICKNESS | LIGHT | CENTER STEP | VENT | TOW | RADAR | YEAR |
|-------------------|-------------------|-------------------|-------|-------------|------|-----|-------|------|
| AM2461SSCK | AERO CLAD | 0.125" | Y | N | Y | Y | Y | N/A |
| AM2460SSCK | AERO CLAD | 0.125" | Y | N | Y | Y | Y | N/A |

NOTE: All bumpers are exclusive to OEM.

**Includes primer coated top trim pieces, lights, wiring harness, rock screen and hardware

The new Hendrickson Bumper without the radar cutout in grill will fit all / any LoneStar produced to date.

The new Hendrickson bumper with cutout in grill will fit all LoneStar with the forward radar option starting in late 2017.

Both bumpers are a direct fit to the chassis and only require two new rear supports. The old supports for the original bumper from the competition will not work on the Hendrickson bumper.

Rock Guard

| PART NO. | MATERIAL / FINISH | GAUGE / THICKNESS | LIGHT | CENTER STEP | VENT | TOW | RADAR | YEAR |
|----------------|-------------------|-------------------|-------|-------------|------|-----|-------|-------------|
| 602300S | Stainless Steel | 0.06" | N/A | N/A | Y | N/A | Y | '18 - Newer |
| 602256S | Stainless Steel | 0.06" | N/A | N/A | Y | N/A | N | '18 - Newer |

INTERNATIONAL

VISION 98 - 9200i / 9400i



| PART NO. | MATERIAL / FINISH | GAUGE / THICKNESS | STYLE | LIGHT | CENTER STEP | VENT | TOW | RADAR | EXCLUSIVE | YEAR | MOUNT / BRACKET |
|------------------|-------------------|-------------------|--------------|-------|-------------|------|-----|-------|-----------|-------------|-----------------|
| AM0490SSC | AERO CLAD® | 0.125" | 12" Set Back | N | N | Y | Y | N | N | '97 - Newer | Face |
| AM0490X | Aluminum Primed | 0.179" | 12" Set Back | N | N | Y | Y | N | N | '97 - Newer | Face |

5000

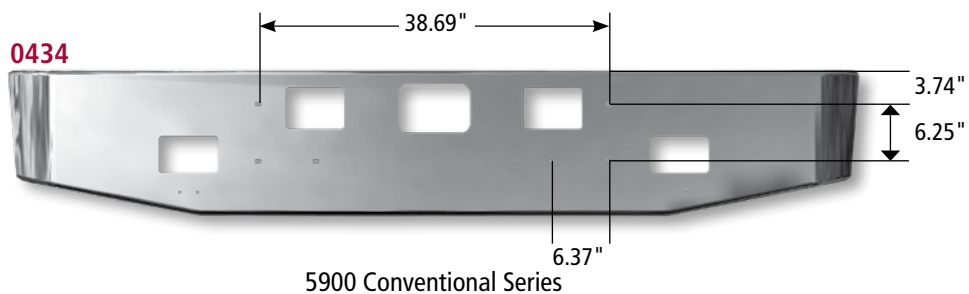

| PART NO. | MATERIAL / FINISH | GAUGE / THICKNESS | STYLE | LIGHT | CENTER STEP | VENT | TOW | RADAR | EXCLUSIVE | YEAR | MOUNT / BRACKET |
|---------------|-------------------|-------------------|------------------|-------------|-------------|------|-----|-------|-----------|------|-----------------|
| 0434 | Chrome | 10Ga | 16" Taper | 2 Rectangle | Y | N | Y | N | N | — | Face |
| 0434SQ | Chrome | 0.122" | 18" Texas Square | 2 Rectangle | Y | N | Y | N | N | — | Face |



INTERNATIONAL



9000, 9900i, 9670 COE & 9370

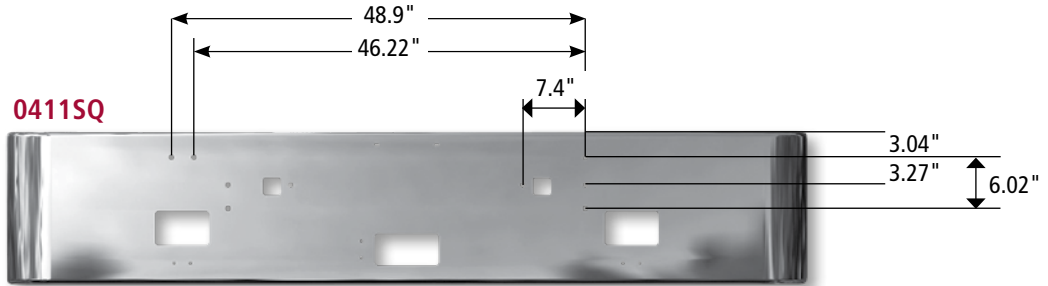

9370 Conventional Series

| PART NO. | MATERIAL / FINISH | GAUGE / THICKNESS | STYLE | LIGHT | CENTER STEP | VENT | TOW | RADAR | EXCLUSIVE | YEAR | MOUNT / BRACKET |
|---------------|-------------------|-------------------|------------------|-------------|-------------|------|-----|-------|-----------|------|-----------------|
| 0410 | Chrome | 10Ga | 16" Taper | N | Y | N | Y | N | N | — | Face |
| 0410SQ | Chrome | 0.125" | 18" Texas Square | N | Y | N | Y | N | N | — | Face |
| 0411 | Chrome | 10Ga | 16" Taper | 2 Rectangle | Y | N | Y | N | N | — | Face |
| 0411SQ | Chrome | 0.125" | 18" Texas Square | 2 Rectangle | Y | N | Y | N | N | — | Face |
| 0416SQ | Chrome | 0.125" | 18" Texas Square | N | N | N | Y | N | N | — | Face |
| 0417SQ | Chrome | 10Ga | 18" Texas Square | 9 Oval | N | N | Y | N | N | — | Face |



INTERNATIONAL

9900i CONVENTIONAL

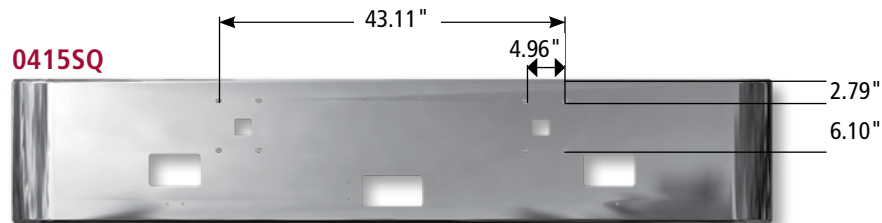

| PART NO. | MATERIAL / FINISH | GAUGE / THICKNESS | STYLE | LIGHT | CENTER STEP | VENT | TOW | RADAR | EXCLUSIVE | YEAR | MOUNT / BRACKET |
|-------------------|-------------------|-------------------|------------------|-------------|-------------|------|-----|-------|-----------|-------------|-----------------|
| 0415 | Chrome | 10Ga | 16" Taper | 2 Rectangle | Y | N | Y | N | N | — | Face |
| 0415NL | Chrome | 10Ga | 16" Taper | N | Y | N | Y | N | N | — | Face |
| 0415NLSQ | Chrome | 0.125" | 18" Texas Square | N | Y | N | Y | N | N | — | Face |
| 0415SQ | Chrome | 0.125" | 18" Texas Square | 2 Rectangle | Y | N | Y | N | N | — | Face |
| 0415SSCSQ* | AERO CLAD® | 0.125" | 18" Texas Square | 2 Rectangle | Y | N | Y | N | N | '96 - Newer | Face |
| 0425SQ | Chrome | 0.125" | 18" Texas Square | N | N | N | Y | N | N | '96 - Newer | Face |
| AM0415SSC | AERO CLAD | 0.16" | 16" Taper | Y | Y | N | Y | N | N | — | Face |

NOTE: AERO CLAD® Texas Square (0415SSCSQ) requires separate purchase of stiffener brackets P/N 3523291C1 LH and 3523292C1 RH.
*Fits 1996 year and newer.

9200 / 9400

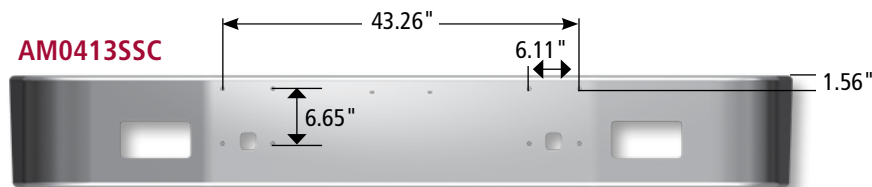

| PART NO. | MATERIAL / FINISH | GAUGE / THICKNESS | STYLE | LIGHT | CENTER STEP | VENT | TOW | RADAR | EXCLUSIVE | YEAR | MOUNT / BRACKET |
|------------------|-------------------|-------------------|----------------|-------|-------------|------|-----|-------|-----------|-------------|-----------------|
| AM0413SSC | AERO CLAD® | 0.125" | 13.5" Set Back | Y | N | N | Y | N | N | '96 - Older | Face |
| AM0414SSC | AERO CLAD | 0.125" | 13.5" Set Back | Y | N | N | Y | N | N | '96 - Older | Face |
| AM0442SSC | AERO CLAD | 0.125" | 12" Set Back | N | N | Y | Y | Y | N | '96 - Newer | Face |



INTERNATIONAL



7000 / WORKSTAR

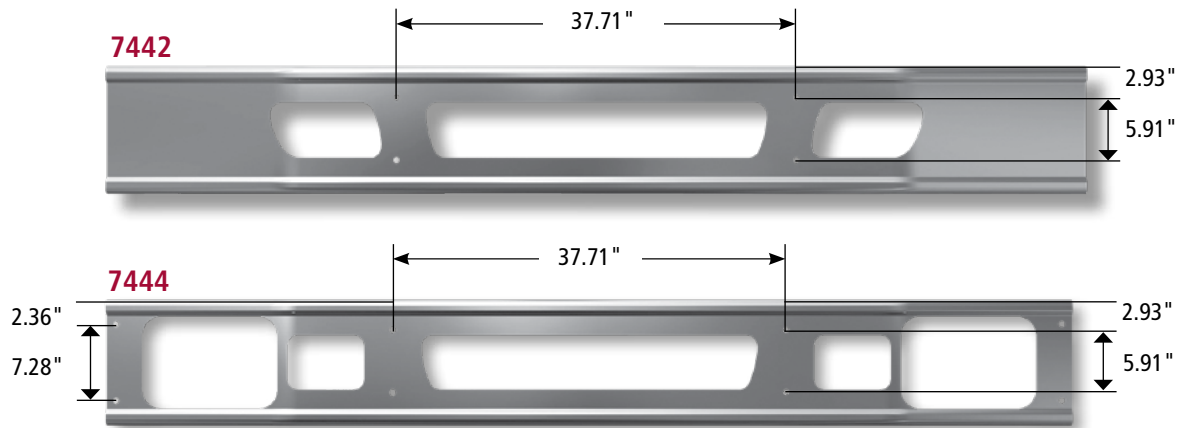

| PART NO. | MATERIAL / FINISH | GAUGE / THICKNESS | STYLE | LIGHT | CENTER STEP | VENT | TOW | RADAR | EXCLUSIVE | YEAR | MOUNT / BRACKET |
|----------------|-------------------|-------------------|-----------------|-------|-------------|------|-----|-------|-----------|------|-----------------|
| 7442BX | Steel Primed | 7Ga | 12" Set Forward | Y | N | Y | Y | N | N | A | Face |
| 7442 | Chrome | 7Ga | 12" Set Forward | Y | N | Y | Y | N | N | A | Face |
| 7442SSC | AERO CLAD® | 0.160" | 12" Set Forward | Y | N | Y | Y | N | N | A | Face |
| 7444BX | Steel Primed | 7Ga | 12" Set Forward | Y | N | Y | Y | N | N | A | Face |
| 7444 | Chrome | 7Ga | 12" Set Forward | Y | N | Y | Y | N | N | A | Face |
| 7444SSC | AERO CLAD | 0.160" | 12" Set Forward | Y | N | Y | Y | N | N | A | Face |
| 7445BX | Steel Primed | 7Ga | 12" Set Back | Y | N | Y | Y | N | N | A | Face |
| 7445 | Chrome | 7Ga | 12" Set Back | Y | N | Y | Y | N | N | A | Face |
| 7445SSC | AERO CLAD | 0.160" | 12" Set Back | Y | N | Y | Y | N | N | A | Face |
| 7467BX | Steel Primed | 7Ga | 12" Set Forward | Y | N | Y | Y | N | Y | A | Face |
| 7467 | Chrome | 7Ga | 12" Set Forward | Y | N | Y | Y | N | Y | A | Face |
| 7468BX | Steel Primed | 7Ga | 12" Set Back | Y | N | Y | Y | N | Y | B | Face |
| 7468 | Chrome | 7Ga | 12" Set Back | Y | N | Y | Y | N | Y | B | Face |
| 7469SSC | AERO CLAD | 0.160" | 12" Set Back | Y | N | Y | Y | N | Y | C | Face |

| APPLICATION GUIDELINES | | |
|------------------------------------|------------------------------------|------------------------------------|
| A | B | C |
| 7300 – Oct. 2001 and Newer | 7300 – Oct. 2001 and Newer | 7400 – July 2001 and Newer |
| 7400 – July 2001 and Newer | 7400 – July 2001 and Newer | 7500 – July 2001 and Newer |
| 7500 – July 2001 and Newer | 7500 – July 2001 and Newer | 7600 – April 2002 and Newer |
| 7600 – April 2002 and Newer | 7600 – April 2002 and Newer | |
| | 7700 – Dec. 2003 and Newer | |



KENWORTH

T300



| PART NO. | MATERIAL / FINISH | GAUGE / THICKNESS | STYLE | LIGHT | CENTER STEP | VENT | TOW | RADAR | EXCLUSIVE | YEAR | MOUNT / BRACKET |
|----------------|-------------------|-------------------|--------------|-------|-------------|------|-----|-------|-----------|------|-----------------|
| 0588SSC | AERO CLAD® | 0.125" | 12" Set Back | N | Y | N | Y | N | N | All | N |
| 0589SSC | AERO CLAD | 0.125" | 12" Set Back | N | N | N | Y | N | N | All | N |
| 7588BX | Steel Primed | 7Ga | 12" Set Back | N | Y | N | Y | N | N | All | N |
| 7589BX | Steel Primed | 7Ga | 12" Set Back | N | N | N | Y | N | N | All | N |

T600



| PART NO. | MATERIAL / FINISH | GAUGE / THICKNESS | STYLE | LIGHT | CENTER STEP | VENT | TOW | RADAR | EXCLUSIVE | YEAR | MOUNT / BRACKET |
|----------------|-------------------|-------------------|--------------|-------|-------------|------|-----|-------|-----------|-----------|-----------------|
| 0561BX | Steel Primed | 10Ga | 14" Set Back | N | Y | Y | Y | Y | N | '85 - '07 | N |
| 0562SSC | AERO CLAD | 0.125" | 14" Set Back | N | Y | Y | Y | Y | N | '85 - '07 | N |



KENWORTH

T800 / T880

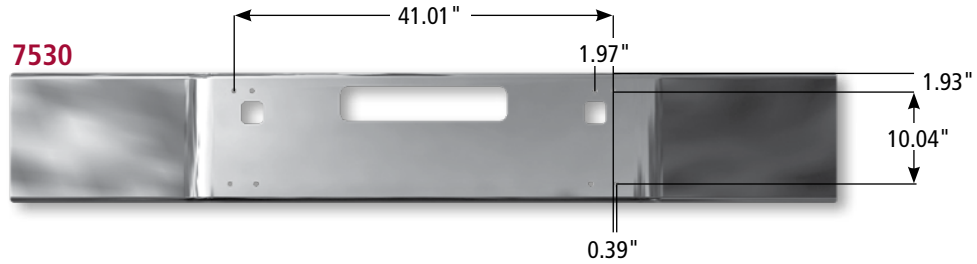

| PART NO. | MATERIAL / FINISH | GAUGE / THICKNESS | STYLE | LIGHT | CENTER STEP | VENT | TOW | RADAR | EXCLUSIVE | YEAR | MOUNT / BRACKET |
|----------------|-------------------|-------------------|--------------|-------------|-------------|------|-----|-------|-----------|-----------|-----------------|
| 0530NT | Chrome | 10Ga | 14" Open End | N | N | Y | N | N | N | '86 - '04 | N |
| 0530 | Chrome | 10Ga | 14" Open End | N | N | Y | Y | N | N | '86 - '04 | N |
| 7530 | Chrome | 7Ga | 14" Open End | N | N | Y | Y | N | N | '86 - '04 | N |
| 7530BX | Steel Primed | 7Ga | 14" Open End | N | N | Y | Y | N | N | '86 - '04 | N |
| 5530SSC | AERO CLAD® | 0.160" | 14" Open End | N | N | Y | Y | N | N | '86 - '04 | N |
| 7531 | Chrome | 7Ga | 14" Open End | 2 Rectangle | N | Y | Y | N | N | '86 - '04 | N |
| 5531SSC | AERO CLAD | 0.160" | 14" Open End | 2 Rectangle | N | Y | Y | N | N | '86 - '04 | N |
| 7540 | Chrome | 7Ga | 14" Taper | N | N | Y | Y | N | Y | '86 - '04 | N |
| 7542** | Chrome | 7Ga | 14" Taper | N | N | Y | Y | N | N | '86 - '04 | N |
| 7543 | Chrome | 7Ga | 14" Taper | 2 Rectangle | N | Y | Y | N | N | '86 - '04 | N |
| 0544** | Chrome | 10Ga | 14" Taper | 2 Rectangle | N | Y | Y | N | N | '86 - '04 | N |

CONVENTIONAL WITH 7-INCH BREAK-BACK

**Surface Mount Hitch



KENWORTH

T800 / T880 cont.

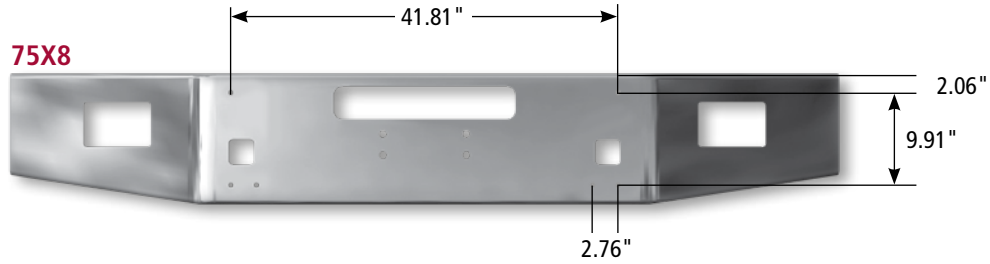

| PART NO. | MATERIAL / FINISH | GAUGE / THICKNESS | STYLE | LIGHT | CENTER STEP | VENT | TOW | RADAR | EXCLUSIVE | YEAR | MOUNT / BRACKET |
|------------------|-------------------|-------------------|--------------|-------------|-------------|------|-----|-------|-----------|-------------|-----------------|
| 55X0NLSSC | AERO CLAD® | 0.160" | 14" Open End | N | N | Y | Y | N | Y | '04 - Newer | N |
| 55X0SSC | AERO CLAD | 0.160" | 14" Open End | 2 Rectangle | N | Y | Y | N | Y | '04 - Newer | N |
| 75X0 | Chrome | 7Ga | 14" Open End | 2 Rectangle | N | Y | Y | N | Y | '04 - Newer | N |
| 75X0R | Chrome | 7Ga | 14" Open End | 2 Round | N | Y | Y | N | N | '04 - Newer | N |
| 75X0NL | Chrome | 7Ga | 14" Open End | N | N | Y | Y | N | Y | '04 - Newer | N |
| 75X2NLPOL | Polished Aluminum | 0.25" | 14" Taper | N | N | Y | Y | N | N | '04 - Newer | N |
| 75X2POL | Polished Aluminum | 0.25" | 14" Taper | 2 Rectangle | N | Y | Y | N | N | '04 - Newer | N |
| 75X2 | Chrome | 7Ga | 14" Taper | 2 Rectangle | N | Y | Y | N | Y | '04 - Newer | N |
| 75X2NL | Chrome | 7Ga | 14" Taper | N | N | Y | Y | N | Y | '04 - Newer | N |
| 75X2RS | Chrome | 7Ga | 14" Taper | 2 Rectangle | N | Y | Y | N | Y | '04 - Newer | N |
| 75X6* | Chrome | 7Ga | 14" Taper | 2 Rectangle | N | Y | Y | N | Y | '04 - Newer | N |
| 75X8** | Chrome | 7Ga | 14" Taper | 2 Rectangle | N | Y | Y | N | N | '04 - Newer | N |
| 75X6NL* | Chrome | 7Ga | 14" Taper | N | N | Y | Y | N | Y | '04 - Newer | N |
| 05X8** | Chrome | 10Ga | 14" Taper | 2 Rectangle | N | Y | Y | N | N | '04 - Newer | N |
| 05X8NL** | Chrome | 10Ga | 14" Taper | N | N | Y | Y | N | N | '04 - Newer | N |

* Recessed Hitch

** Surface Mount Hitch

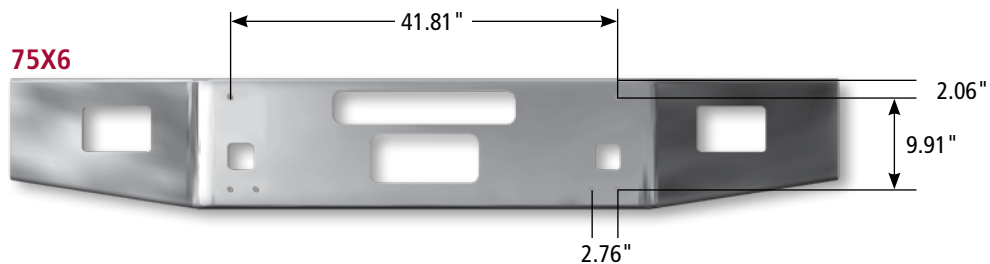

KENWORTH

W900A

| PART NO. | MATERIAL / FINISH | GAUGE / THICKNESS | STYLE | LIGHT | CENTER STEP | VENT | TOW | RADAR | EXCLUSIVE | YEAR | MOUNT / BRACKET |
|----------|-------------------|-------------------|--------------|-------|-------------|------|-----|-------|-----------|-----------|-----------------|
| 7510 | Chrome | 7Ga | 16" Gullwing | N | N | N | Y | N | N | '67 - '81 | N |

W900B / W900L

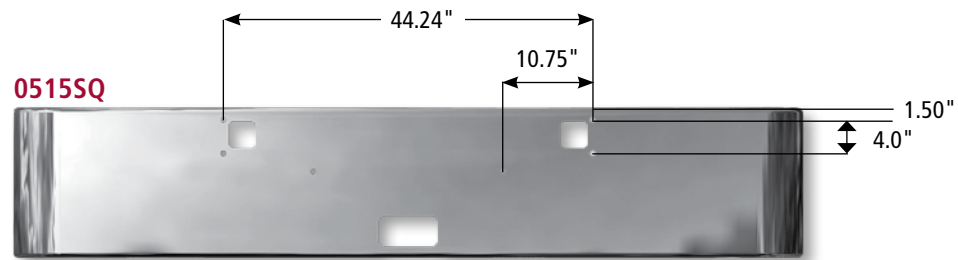

| PART NO. | MATERIAL / FINISH | GAUGE / THICKNESS | STYLE | LIGHT | CENTER STEP | VENT | TOW | RADAR | EXCLUSIVE | YEAR | MOUNT / BRACKET | TIRE SHIELD |
|-----------|-------------------|-------------------|------------------|-------------|-------------|------|-----|-------|-----------|-------------|-----------------|-------------|
| 7512SQ | Chrome | 7Ga | 18" Texas Square | N | N | N | Y | N | N | '82 - '10 | N | Y |
| 0574SQ | Chrome | 10Ga | 18" Texas Square | 9 Oval | N | N | Y | N | N | '82 - '10 | N | Y |
| 0503NSSQ | Chrome | 10Ga | 18" Texas Square | 2 Rectangle | Y | N | Y | N | N | '82 - '10 | N | N |
| 0514SQ | Chrome | 10Ga | 18" Texas Square | 2 Rectangle | Y | N | Y | N | N | '90 - '10 | N | Y |
| 7514 | Chrome | 7Ga | 16" Taper | 2 Rectangle | Y | N | Y | N | N | '90 - '10 | N | Y |
| 7514SQ | Chrome | 7Ga | 18" Texas Square | 2 Rectangle | Y | N | Y | N | N | '90 - '10 | N | Y |
| 0515IN18 | Chrome | 10Ga | 18" Taper | N | Y | N | Y | N | N | '82 - Newer | N | N |
| 0515SSCSQ | AERO CLAD® | 0.125" | 18" Texas Square | N | Y | N | Y | N | Y | '82 - Newer | Y | Y |
| 0515NSSQ | Chrome | 10Ga | 18" Texas Square | N | Y | N | Y | N | N | '82 - Newer | N | N |
| 0515SQ | Chrome | 10Ga | 18" Texas Square | N | Y | N | Y | N | N | '82 - Newer | N | Y |
| 7514NS | Chrome | 7Ga | 16" Taper | 2 Rectangle | Y | N | Y | N | N | '82 - Newer | N | N |
| 7515NS | Chrome | 7Ga | 16" Taper | N | Y | N | Y | N | N | '82 - Newer | N | N |
| 7515 | Chrome | 7Ga | 16" Taper | N | Y | N | Y | N | N | '82 - Newer | N | Y |
| 7515SQ | Chrome | 7Ga | 18" Texas Square | N | Y | N | Y | N | N | '82 - Newer | N | Y |
| 0521SQ | Chrome | 10Ga | 20" Box | N | N | N | Y | N | N | '82 - Newer | N | Y |
| 0522SQ | Chrome | 10Ga | 18" Texas Square | N | N | N | Y | N | N | '82 - Newer | N | Y |

KENWORTH

T660

AERO CLAD® Stainless Steel Clad Aluminum Bumper

AERO CLAD® Features and Benefits

- Durable, bright mirrored finish
- Finish 10 times thicker than chrome
- Resists corrosion
- Resists cracking, pitting, peeling and fading
- Tested fuel efficient design
- High ground clearance
- Environmentally green alternative to chrome plating
- Minor abrasions can be buffed
- Full five-year limited warranty*



| PART NO. | MATERIAL / FINISH | GAUGE / THICKNESS | STYLE | LIGHT | CENTER STEP | VENT | TOW | RADAR | EXCLUSIVE | YEAR | MOUNT / BRACKET |
|-------------------|-------------------|-------------------|--------------|-------|-------------|------|-----|-------|-----------|-------------|-----------------|
| 05R1NLSSC | AERO CLAD® | 0.125" | 14" Set Back | N | N | Y | Y | N | N | '08 - Newer | Y |
| 05R1NLVSSC | AERO CLAD | 0.125" | 14" Set Back | N | N | Y | Y | Y | N | '08 - Newer | Y |
| 05R1SSC* | AERO CLAD | 0.125" | 14" Set Back | Y | N | Y | Y | N | N | '08 - Newer | Y |
| 05R1VSSC* | AERO CLAD | 0.125" | 14" Set Back | Y | N | Y | Y | Y | N | '08 - Newer | Y |
| 05R1NLBAX | Steel Primed | 10Ga | 14" Set Back | N | N | Y | Y | N | N | '08 - Newer | Y |
| 05R1NLVBAX | Steel Primed | 10Ga | 14" Set Back | N | N | Y | Y | Y | N | '08 - Newer | Y |
| 05R1VBAX* | Steel Primed | 10Ga | 14" Set Back | Y | N | Y | Y | Y | N | '08 - Newer | Y |

*Includes light bezel trim

T660 AIR DAM KIT

| PART NUMBER | MATERIAL / FINISH |
|----------------|------------------------------------|
| 05R1AD | Full air dam with hardware |
| 05R1ADL | Driver left side with hardware |
| 05R1ADR | Passenger right side with hardware |



MACK

CH600 / CH

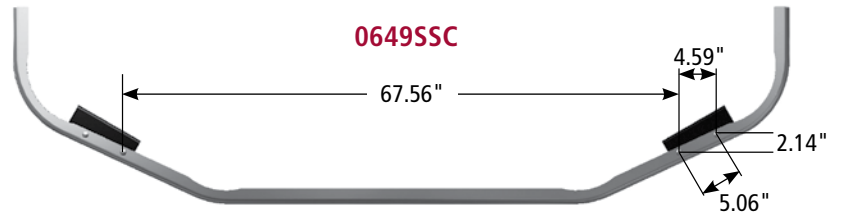

| PART NO. | MATERIAL / FINISH | GAUGE / THICKNESS | STYLE | LIGHT | CENTER STEP | VENT | TOW | RADAR | EXCLUSIVE | YEAR | MOUNT / BRACKET |
|----------------|-----------------------|-------------------|-------------------|-------|-------------|------|-----|-------|-----------|-------------|-----------------|
| 0636BSX | Steel Primed | 10Ga | 13.5" Set Forward | N | Y | N | Y | N | N | '96 - Newer | N |
| 0636SSC | AERO CLAD® | 0.125" | 13.5" Set Forward | N | Y | N | Y | N | N | '96 - Newer | N |
| 0637SSC | AERO CLAD | 0.125" | 13.5" Set Forward | Y | Y | N | Y | N | N | '96 - Newer | Y |
| 0648BSX | Steel Primed | 10Ga | 13.5" Set Back | N | Y | N | Y | N | N | '96 - Newer | Y |
| 0648SSC | AERO CLAD | 0.125" | 13.5" Set Back | N | Y | N | Y | N | N | '96 - Newer | Y |
| 0649BLK | Black Paintable (ABS) | 0.187" | 17.65" Set Back | Y | Y | Y | Y | N | N | '04 - '07 | N |
| 0649BSX | Steel Primed | 10Ga | 17.65" Set Back | Y | Y | Y | Y | N | N | — | Y |
| 0649SSC | AERO CLAD | 0.125" | 13.5" Set Back | Y | Y | N | Y | N | N | '96 - Newer | Y |
| 0653SSC | AERO CLAD | 0.125" | 13.5" Set Back | N | Y | N | Y | N | N | '96 - '04 | Y |





CL

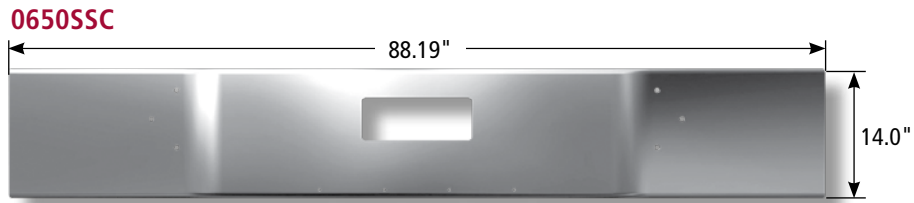

| PART NO. | MATERIAL / FINISH | GAUGE / THICKNESS | STYLE | LIGHT | CENTER STEP | VENT | TOW | RADAR | EXCLUSIVE | YEAR | MOUNT / BRACKET |
|----------------|-------------------|-------------------|----------|-------|-------------|------|-----|-------|-----------|------|-----------------|
| 0650SSC | AERO CLAD® | 0.125" | Set Back | N | Y | N | N | N | N | — | N |
| 0651SSC | AERO CLAD | 0.125" | Set Back | N | N | N | Y | N | N | — | N |

DM

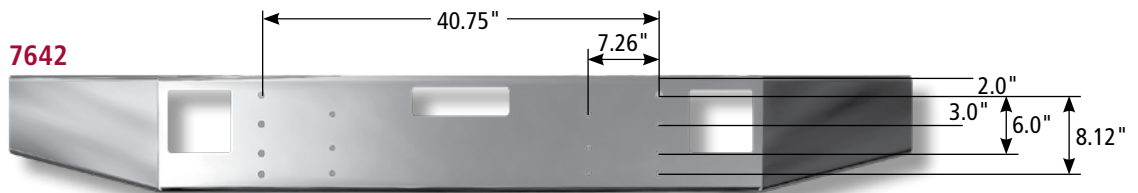

| PART NO. | MATERIAL / FINISH | GAUGE / THICKNESS | STYLE | LIGHT | CENTER STEP | VENT | TOW | RADAR | EXCLUSIVE | YEAR | MOUNT / BRACKET |
|-------------|-------------------|-------------------|-----------|-------|-------------|------|-----|-------|-----------|-----------|-----------------|
| 7642 | Chrome | 8Ga | 12" Taper | N | N | Y | Y | N | N | '86 - '97 | N |

GRANITE

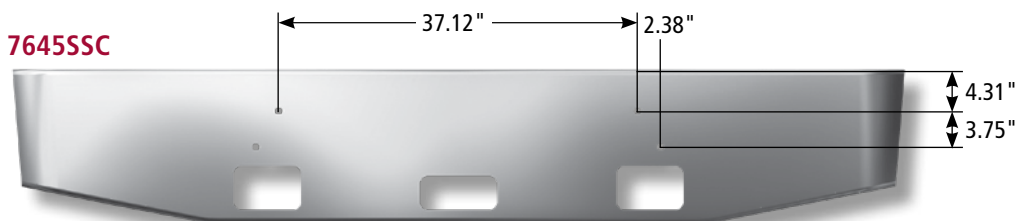

| PART NO. | MATERIAL / FINISH | GAUGE / THICKNESS | STYLE | LIGHT | CENTER STEP | VENT | TOW | RADAR | EXCLUSIVE | YEAR | MOUNT / BRACKET |
|----------------|-------------------|-------------------|-----------------------|-------|-------------|------|-----|-------|-----------|------|-----------------|
| 7645SSC | AERO CLAD | 0.160" | Set Forward 16" Taper | N | Y | N | Y | N | N | All | N |



R

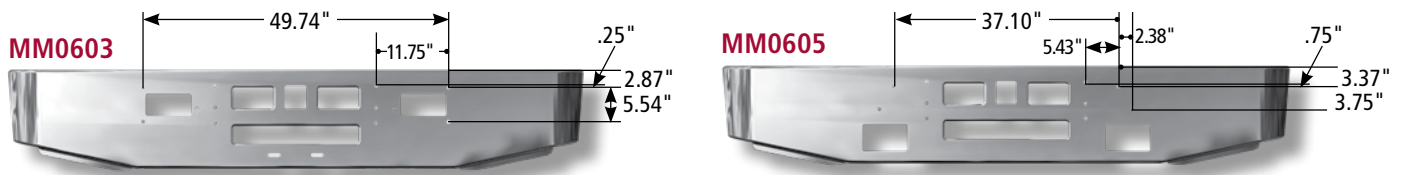

| PART NO. | MATERIAL / FINISH | GAUGE / THICKNESS | STYLE | LIGHT | CENTER STEP | VENT | TOW | RADAR | EXCLUSIVE | YEAR | MOUNT / BRACKET |
|---------------|-------------------|-------------------|-----------|-------|-------------|------|-----|-------|-----------|-------------|-----------------|
| MM0603 | Chrome | 10Ga | 16" Taper | N | N | Y | Y | N | Y | '97 - Newer | N |
| MM0605 | Chrome | 10Ga | 16" Taper | N | N | Y | Y | N | Y | All | N |

RD

| PART NO. | MATERIAL / FINISH | GAUGE / THICKNESS | STYLE | LIGHT | CENTER STEP | VENT | TOW | RADAR | EXCLUSIVE | YEAR | MOUNT / BRACKET |
|--------------|-------------------|-------------------|----------|-------|-------------|------|-----|-------|-----------|-----------|-----------------|
| 7643 | Chrome | 8Ga | Set Back | N | N | N | N | N | Y | '89 - '98 | N |
| 7644* | Chrome | 8Ga | Set Back | N | N | N | Y | N | Y | — | N |

*Includes cow catcher holes

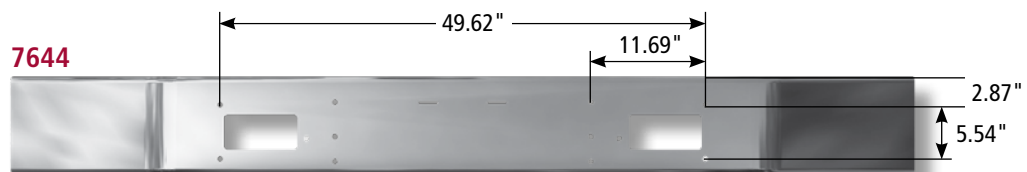

SET BACK AXLE WITH TOW HOLES AND COW CATCHER HOLES

SUPERLINER II

| PART NO. | MATERIAL / FINISH | GAUGE / THICKNESS | STYLE | LIGHT | CENTER STEP | VENT | TOW | RADAR | EXCLUSIVE | YEAR | MOUNT / BRACKET |
|---------------|-------------------|-------------------|-----------|-------|-------------|------|-----|-------|-----------|------|-----------------|
| MM0613 | Chrome | 10Ga | 15" Taper | N | Y | N | N | N | Y | — | N |

U

| PART NO. | MATERIAL / FINISH | GAUGE / THICKNESS | STYLE | LIGHT | CENTER STEP | VENT | TOW | RADAR | EXCLUSIVE | YEAR | MOUNT / BRACKET |
|-----------------|-------------------|-------------------|-----------|-------|-------------|------|-----|-------|-----------|------|-----------------|
| 0603 | Chrome | 10Ga | 16" Taper | N | N | Y | Y | N | N | — | N |
| MM0605NL | Chrome | 10Ga | 16" Taper | N | N | Y | Y | N | Y | — | N |

Pinnacle CXU / Vision CX

H AERO CLAD® Stainless Steel Clad Aluminum Bumper

AERO CLAD® Features and Benefits

- Smart Way Certified
- Durable, bright mirrored finish
- Finish 10 times thicker than chrome
- Resists corrosion
- Resists cracking, pitting, peeling and fading
- Lightweight design
- Minor abrasions can be buffed
- Full five-year limited warranty



| PART NO. | MATERIAL / FINISH | GAUGE / THICKNESS | STYLE | LIGHT | CENTER STEP | VENT | TOW | RADAR | EXCLUSIVE | YEAR | MOUNT / BRACKET* |
|--------------------|-------------------|-------------------|----------|-------|-------------|------|-----|-------|-----------|-------------|------------------|
| 7665SSC | AERO CLAD® | 0.160" | Set Back | N | Y | N | Y | N | Y | '17 - Newer | N |
| 7664SSC | AERO CLAD | 0.160" | Set Back | Y | Y | N | Y | N | Y | '17 - Newer | N |
| MM5620NLSSC | AERO CLAD | 0.160" | Set Back | N | Y | Y | Y | N | Y | '17 - Newer | N |
| MM5260SSC | AERO CLAD | 0.160" | Set Back | Y | Y | Y | Y | N | Y | '17 - Newer | N |

NOTE: All ALL MAKES part numbers are exclusive Mack / Volvo.

NOTE: OE mounting brackets are not sold through Hendrickson, must be purchased through the OEM channel.



PETERBILT

330

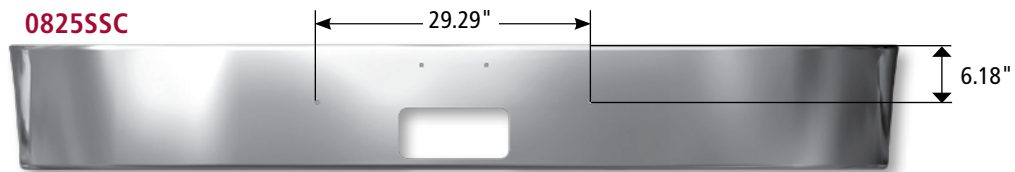

| PART NO. | MATERIAL / FINISH | GAUGE / THICKNESS | STYLE | LIGHT | CENTER STEP | VENT | TOW | RADAR | EXCLUSIVE | YEAR | MOUNT / BRACKET |
|----------------|-------------------|-------------------|----------------|-------|-------------|------|-----|-------|-----------|-------------|-----------------|
| 0825SSC | AERO CLAD® | 0.125" | 13.5" Set Back | N | N | N | Y | N | Y | '02 - '08 | N |
| 0826SSC | AERO CLAD | 0.125" | 16" Set Back | N | N | N | Y | N | Y | '97 - Newer | N |

359 CONVENTIONAL 67-'86 / 352 COE 67-'80

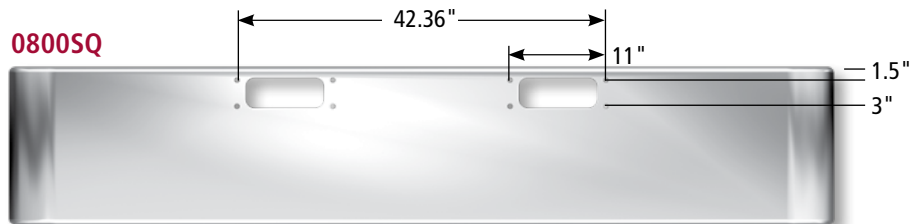

| PART NO. | MATERIAL / FINISH | GAUGE / THICKNESS | STYLE | LIGHT | CENTER STEP | VENT | TOW | RADAR | EXCLUSIVE | YEAR | MOUNT / BRACKET |
|---------------|-------------------|-------------------|---------|-------|-------------|------|-----|-------|-----------|-----------|-----------------|
| 0800SQ | Chrome | 10Ga | 18" TSQ | N | N | N | Y | N | N | '67 - '86 | N |

367 / 567

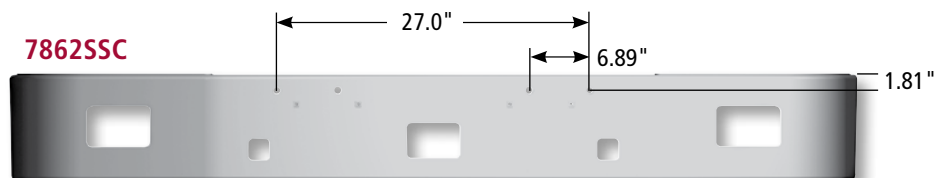

| PART NO. | MATERIAL / FINISH | GAUGE / THICKNESS | STYLE | LIGHT | CENTER STEP | VENT | TOW | RADAR | EXCLUSIVE | YEAR | MOUNT / BRACKET |
|-------------------|-------------------|-------------------|--------------|-------|-------------|------|-----|-------|-----------|-------------|-----------------|
| 7862SSC* | AERO CLAD | 0.160" | 12" Set Back | Y | N | N | Y | N | N | '07 - Newer | Y |
| 7862NLSSC* | AERO CLAD | 0.160" | 12" Set Back | N | N | N | Y | N | N | '07 - Newer | Y |

*Includes treadplates

PETERBILT

365 SFFA, 367 SFFA, 388, 389

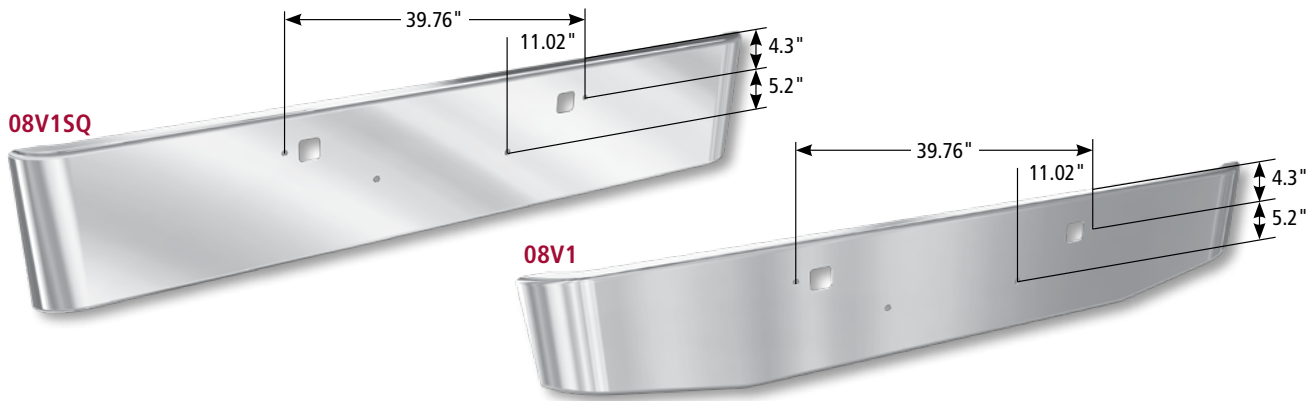

| PART NO. | MATERIAL / FINISH | GAUGE / THICKNESS | STYLE | LIGHT | CENTER STEP | VENT | TOW | RADAR | EXCLUSIVE | YEAR | MOUNT / BRACKET | TIRE SHIELD |
|--------------------|-------------------|-------------------|------------------|-------|-------------|------|-----|-------|-----------|-------------|-----------------|-------------|
| 08V1 | Chrome | 10Ga | 16" Taper | N | N | N | Y | N | N | '06 - Newer | N | N |
| 08V11NSSQ | Chrome | 10Ga | 18" Texas Square | N | N | N | Y | N | N | '06 - Newer | N | N |
| 08V1SQ* | Chrome | 10Ga | 18" Texas Square | N | N | N | Y | N | Y | '06 - Newer | N | Y |
| 08V2SQ** | Chrome | 10Ga | 18" Texas Square | N | N | N | Y | N | N | '06 - Newer | N | Y |
| 08V3 | Chrome | 10Ga | 16" Taper | N | N | N | Y | N | N | '06 - Newer | N | N |
| 08V4 | Chrome | 10Ga | 16" Taper | N | N | N | Y | N | N | '06 - Newer | N | N |
| 08V5 | Chrome | 10Ga | 16" Taper | N | N | N | Y | N | N | '06 - Newer | N | N |
| 78V1SQ | Chrome | 7Ga | 18" Texas Square | N | N | N | Y | N | N | '06 - Newer | N | Y |
| 08V11N12 | Chrome | 10Ga | 12" Taper | N | N | N | Y | N | N | All | N | N |
| 78V1SQ18 | Chrome | 7Ga | 18" boxed end | N | N | N | Y | N | N | All | N | Y |
| 78V1SQ20 | Chrome | 7Ga | 20" boxed end | N | N | N | Y | N | N | All | N | Y |
| 08V11NS | Chrome | 10Ga | 16" Taper | Y | N | N | Y | N | N | All | N | N |
| 08V11NSSQ | Chrome | 10Ga | 18" Texas Sq | N | N | N | Y | N | N | All | N | N |
| 08V11NSSQK | Chrome | 10Ga | 18" Texas Sq | N | N | N | Y | N | N | All | N | N |
| 08V12SQ | Chrome | 10Ga | 18" Texas Sq | Y | N | N | Y | N | N | All | N | Y |
| 78V11NSSQ18 | Chrome | 7Ga | 18" boxed end | Y | N | N | Y | N | N | All | N | N |
| 78V11NSSQ20 | Chrome | 7Ga | 20" boxed end | Y | N | N | Y | N | N | All | N | N |
| 08V13SQ | Chrome | 10Ga | 18" boxed end | N | N | N | Y | N | N | All | N | Y |
| 08V8NLSQ | Chrome | 10Ga | 18" Texas Sq | N | N | N | Y | N | Y | All | N | Y |
| 08V1NTSQP | Chrome | 10Ga | 18" Texas Sq | N | N | N | N | N | Y | '06 - Newer | N | Y |

*Recessed Hitch

**Surface Mount Hitch



PETERBILT

357 / 378 / 379

| PART NO. | MATERIAL / FINISH | GAUGE / THICKNESS | STYLE | LIGHT | CENTER STEP | VENT | TOW | RADAR | EXCLUSIVE | YEAR | MOUNT / BRACKET | TIRE SHIELDS |
|-------------------|--------------------|-------------------|---------------|-------------|-------------|------|-----|-------|-----------|-----------|-----------------|--------------|
| 0804 | Chrome | 10Ga | 16" Taper | N | N | N | Y | N | N | '87 - '06 | N | Y |
| 0804NS | Chrome | 10Ga | 16" Taper | N | N | N | Y | N | N | '87 - '07 | N | N |
| 0805 | Chrome | 10Ga | 16" Taper | 2 Rectangle | N | N | Y | N | N | '87 - '06 | N | Y |
| 0813* | Chrome | 10Ga | 16" Taper | N | N | N | Y | N | N | '87 - '06 | N | Y |
| 0894 | Chrome | 10Ga | 16" Taper | N | N | N | Y | N | N | '87 - '07 | N | Y |
| 7804 | Chrome | 7Ga | 16" Taper | N | N | N | Y | N | N | '87 - '07 | N | Y |
| 0804IN12 | Chrome | 10Ga | 12" Taper | N | N | N | Y | N | N | '87 - '06 | N | N |
| 0804NSSQ | Chrome | 10Ga | 18" Texas Sq | N | N | N | Y | N | N | '87 - '06 | N | N |
| 0804NTSQ | Chrome | 10Ga | 18" Texas Sq | N | N | N | N | N | N | '87 - '06 | N | Y |
| 0804SQ | Chrome | 10Ga | 18" Texas Sq | N | N | N | Y | N | N | '87 - '06 | N | Y |
| 0804SSC | AERO CLAD® | 0.160" | 16" Taper | N | N | N | Y | N | N | '87 - '06 | Y | N |
| 0804STQ | Polished Stainless | 11Ga | 18" Texas Sq | N | N | N | Y | N | N | '87 - '06 | N | Y |
| 0805NSSQ | Chrome | 10Ga | 18" Texas Sq | 2 Rectangle | N | N | Y | N | N | '88 - '07 | N | N |
| 0805SQ | Chrome | 10Ga | 18" Texas Sq | 2 Rectangle | N | N | Y | N | N | '87 - '06 | N | Y |
| 0805NS | Chrome | 10Ga | 16" Taper | 2 Rectangle | N | N | Y | N | N | '87 - '07 | N | N |
| 0807NSSQ | Chrome | 10Ga | 18" Boxed End | N | N | N | Y | N | N | '87 - '06 | N | N |
| 0807SQ | Chrome | 10Ga | 18" Boxed End | N | N | N | Y | N | N | '87 - '06 | N | Y |
| 0809NSSQ20 | Chrome | 10Ga | 20" Boxed End | N | N | N | Y | N | N | '88 - '07 | N | N |
| 0809SQ20 | Chrome | 10Ga | 20" Boxed End | N | N | N | Y | N | N | '88 - '07 | N | Y |
| 0844SQ | Chrome | 10Ga | 18" Texas Sq | 4 Oval | N | N | Y | N | N | '87 - '06 | N | Y |
| 0864SQ | Chrome | 10Ga | 18" Texas Sq | 6 Oval | N | N | Y | N | N | '87 - '06 | N | Y |
| 0874SQ | Chrome | 10Ga | 18" Texas Sq | 9 Oval | N | N | Y | N | N | '87 - '06 | N | Y |
| 0884SQ | Chrome | 10Ga | 18" Texas Sq | 15 Round | N | N | Y | N | N | '87 - '06 | N | Y |
| 7804NS | Chrome | 7Ga | 16" Taper | N | N | N | Y | N | N | '88 - '07 | N | N |
| 7804SQ | Chrome | 7Ga | 18" Texas Sq | N | N | N | Y | N | N | '88 - '07 | N | Y |
| 7807NSSQ | Chrome | 7Ga | 18" Boxed End | N | N | N | Y | N | N | '88 - '07 | N | N |
| 7807SQ | Chrome | 7Ga | 18" Boxed End | N | N | N | Y | N | N | '88 - '07 | N | Y |
| 7809NSSQ20 | Chrome | 7Ga | 20" Boxed End | N | N | N | Y | N | N | '88 - '07 | N | N |
| 7809SQ20 | Chrome | 7Ga | 20" Boxed End | N | N | N | Y | N | N | '88 - '07 | N | Y |
| 0895IN12P | Chrome | 10Ga | 12" Taper | Y | N | N | Y | N | N | '88 - '07 | N | N |
| 08954IN12P | Chrome | 10Ga | 12" Taper | N | N | N | Y | N | N | '88 - '07 | N | N |

*Fits logger



PETERBILT

385

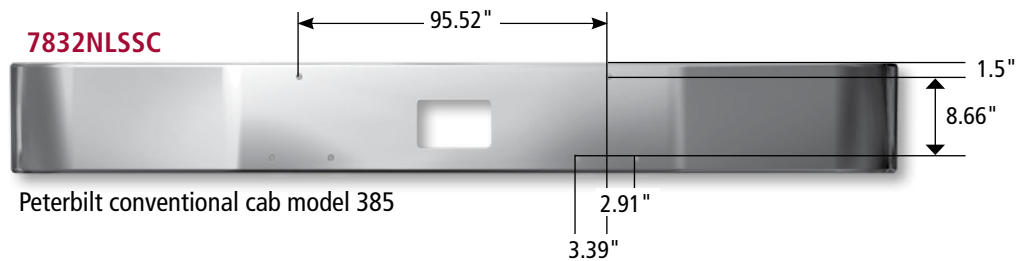

| PART NO. | MATERIAL / FINISH | GAUGE / THICKNESS | STYLE | LIGHT | CENTER STEP | VENT | TOW | RADAR | EXCLUSIVE | YEAR | MOUNT / BRACKET |
|------------------|-------------------|-------------------|--------------|-------------|-------------|------|-----|-------|-----------|-----------|-----------------|
| 7832NLSSC | AERO CLAD® | 0.160" | 12" Set Back | N | N | N | Y | N | N | '96 - '07 | Y |
| 7832SSC | AERO CLAD | 0.160" | 12" Set Back | 2 Rectangle | N | N | Y | N | N | '96 - '07 | Y |

387

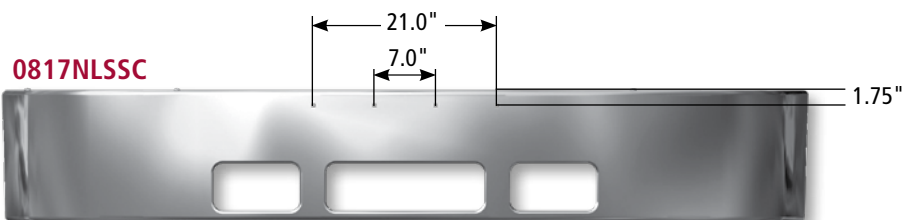

| PART NO. | MATERIAL / FINISH | GAUGE / THICKNESS | STYLE | LIGHT | CENTER STEP | VENT | TOW | RADAR | EXCLUSIVE | YEAR | MOUNT / BRACKET |
|------------------|-------------------|-------------------|--------------|-------------|-------------|------|-----|-------|-----------|-----------|-----------------|
| 0817NLSSC | AERO CLAD | 0.125" | 15" Set Back | N | Y | N | Y | N | Y | '02 - '10 | Y |
| 0817SSC | AERO CLAD | 0.125" | 15" Set Back | 2 Rectangle | Y | N | Y | N | Y | '02 - '10 | Y |
| 0818NLSSC | AERO CLAD | 0.125" | 15" Set Back | N | Y | N | Y | Y | Y | '02 - '10 | Y |
| 0818SSC | AERO CLAD | 0.125" | 15" Set Back | 2 Rectangle | Y | N | Y | Y | Y | '02 - '10 | Y |



PETERBILT

384 / 386

AERO CLAD®

Stainless Steel Clad
Aluminum Bumper

Features and Benefits

- Durable, bright mirrored finish
- Finish 10 times thicker than chrome
- Resists corrosion
- Resists cracking, pitting, peeling and fading
- Smartway package compliant
- Minor abrasions can be buffed
- Full five-year limited warranty*



| PART NO. | MATERIAL / FINISH | GAUGE / THICKNESS | STYLE | LIGHT | CENTER STEP | VENT | TOW | RADAR | EXCLUSIVE | YEAR | MOUNT / BRACKET |
|------------------|-------------------|-------------------|----------------|-------------|-------------|------|-----|-------|-----------|-------------|-----------------|
| 0889NLSSC | AERO CLAD® | 0.125" | 13.5" Set Back | N | Y | N | Y | N | Y | '06 - Newer | Y |
| 0889SSC | AERO CLAD | 0.125" | 13.5" Set Back | 2 Rectangle | Y | N | Y | N | Y | '06 - Newer | Y |

When replacing an OE composite molded bumper, spacers N80 - 6006 & N80 - 6006R are required.
No spacers required when replacing OE metal bumper.

587

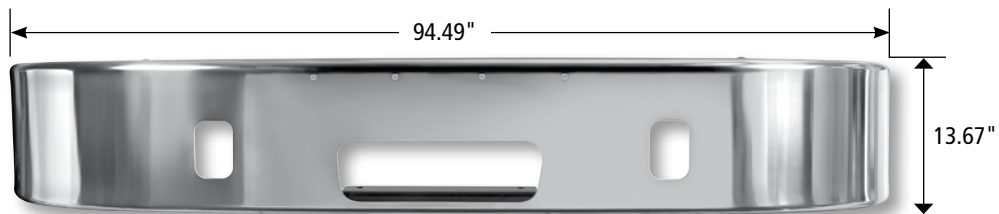

| PART NO. | MATERIAL / FINISH | GAUGE / THICKNESS | STYLE | LIGHT | CENTER STEP | VENT | TOW | RADAR | EXCLUSIVE | YEAR | MOUNT / BRACKET |
|------------------|-------------------|-------------------|----------------|-------|-------------|------|-----|-------|-----------|------|-----------------|
| 08E0NLSSC | AERO CLAD | 0.125" | 13.5" Set Back | N | Y | N | Y | N | Y | ALL | Y |

VOLVO



VNM

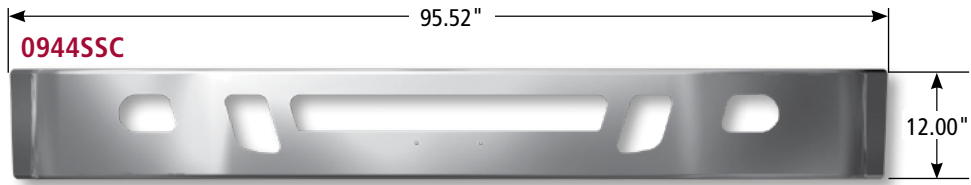

| PART NO. | MATERIAL / FINISH | GAUGE / THICKNESS | STYLE | LIGHT | CENTER STEP | VENT | TOW | RADAR | EXCLUSIVE | YEAR | MOUNT / BRACKET |
|----------------|-------------------|-------------------|----------|-------|-------------|------|-----|-------|-----------|-------------|-----------------|
| 0944SSC | AERO CLAD® | 0.125" | Set Back | Y | N | Y | Y | N | N | '04 - Newer | Bracket |

WG

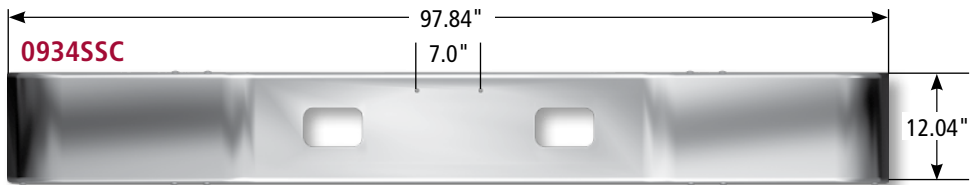

| PART NO. | MATERIAL / FINISH | GAUGE / THICKNESS | STYLE | LIGHT | CENTER STEP | VENT | TOW | RADAR | EXCLUSIVE | YEAR | MOUNT / BRACKET |
|----------------|-------------------|-------------------|----------|-------|-------------|------|-----|-------|-----------|------|-----------------|
| 0934SSC | AERO CLAD | 0.125" | Set Back | Y | N | N | N | N | Y | — | Bracket |





VNL

AERO CLAD®

Stainless Steel Clad
Aluminum Bumper

AERO CLAD® Features and Benefits

- Tested fuel efficient design
- Easy installation to factory mounts
- Mounting brackets included
- Durable, bright mirrored finish
- Finish 10 times thicker than chrome
- Resists corrosion
- Lightweight
- Resists cracking, pitting, peeling and fading
- Minor abrasions can be buffed
- Full five-year limited warranty*



MM0960SSC
(0961ADA-Optional)



STEEL 10-GAUGE BUMPER

Features and Benefits

- Easy installation to factory mounts
- Mounting brackets included
- Corrosion resistant E-coat finish, ready for top coat
- Manufactured with high-impact corrosion resistant steel
- Optional air dam that bolts up to factory installed belly pan can be attached to this bumper
- One-year limited warranty*



MM0961BAX



VNL cont.

| PART NO. | MATERIAL / FINISH | GAUGE / THICKNESS | STYLE | LIGHT | CENTER STEP | VENT | TOW | RADAR | EXCLUSIVE | YEAR | MOUNT / BRACKET |
|----------------------|-------------------|-------------------|-----------------|-------|-------------|------|-----|-------|-----------|-------------|-----------------|
| 0935SSC | AERO CLAD® | 0.125" | — | N | N | Y | Y | N | N | '98 - '03 | Bracket |
| 0940SSC | AERO CLAD | 0.125" | — | N | N | Y | Y | N | N | '98 - '03 | Bracket |
| MM0960NLSSC** | AERO CLAD | 0.125" | — | N | N | Y | Y | N | Y | '03 - Newer | Bracket |
| MM0960SSC** | AERO CLAD | 0.125" | — | Y | N | Y | Y | N | Y | '03 - Newer | Bracket |
| MM0961BAX | Steel Prime | 10Ga | — | Y | N | Y | Y | N | Y | '03 - Newer | Bracket |
| MM0961NLBAX | Steel Prime | 10Ga | — | N | N | Y | Y | N | Y | '03 - Newer | Bracket |
| MM0961NLSSC* | AERO CLAD | 0.125" | — | N | N | Y | Y | N | Y | '03 - Newer | Bracket |
| MM0961SSC* | AERO CLAD | 0.125" | — | Y | N | Y | Y | N | Y | '03 - Newer | Bracket |
| 0961ADA | ABS | 0.187" | VNL AIR DAM KIT | — | — | — | — | — | — | — | — |

*Extended - to be used with large wheel trim 24.5" diameter tire.

**Basic - to be used with small wheel trim 22.5" diameter tire.



WESTERN STAR



CONVENTIONAL / 4964 CONSTELLATION & HERITAGE

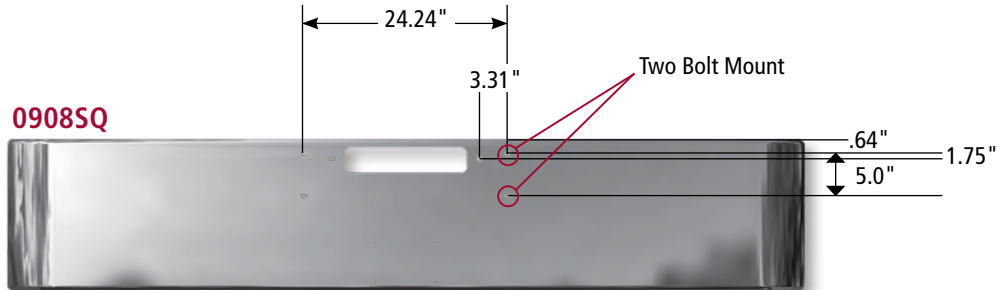

| PART NO. | MATERIAL / FINISH | GAUGE / THICKNESS | STYLE | LIGHT | CENTER STEP | VENT | TOW | RADAR | EXCLUSIVE | YEAR | MOUNT / BRACKET |
|---------------|-------------------|-------------------|------------------|-------------|-------------|------|-----|-------|-----------|-----------|-----------------|
| 0907 | Chrome | 10Ga | 16" Taper | 2 Rectangle | N | N | N | N | N | '89 - '07 | Face |
| 0907SQ | Chrome | 10Ga | 18" Texas Square | 2 Rectangle | N | N | N | N | N | '89 - '07 | Face |
| 0908 | Chrome | 10Ga | 16" Taper | N | N | N | N | N | N | '89 - '07 | Face |
| 0908SQ | Chrome | 0.125" | 18" Texas Square | N | N | N | N | N | N | '89 - '07 | Face |
| 0909SQ | Chrome | 0.125" | 18" Texas Square | N | N | N | N | N | N | '89 - '07 | Face |
| 0910 | Chrome | 10Ga | 16" Taper | N | N | N | N | N | N | '89 - '07 | Face |
| 0911SQ | Chrome | 10Ga | 18" Texas Square | 2 Rectangle | N | N | N | N | N | '89 - '07 | Face |
| 0912SQ | Chrome | 0.125" | 18" Texas Square | 8 Oval | N | N | N | N | N | '89 - '07 | Face |
| 0913SQ | Chrome | 0.125" | 18" Texas Square | 8 Oval | N | N | N | N | N | '89 - '07 | Face |
| 7907 | Chrome | 0.152" | 16" Taper | 2 Rectangle | N | N | N | N | N | '89 - '07 | Face |
| 7908 | Chrome | 0.152" | 16" Taper | N | N | N | N | N | N | '89 - '07 | Face |



Finding the right bumper is as easy as 1-2-3.

Step 1.

Visit www.hendrickson-intl.com/bumper to utilize the bumper selector tool.

Step 2.

Configure your bumper using easy to navigate menu of options to obtain the Hendrickson ALL Makes part number.

Step 3.

Email, print or send your bumper configuration with a simple click.

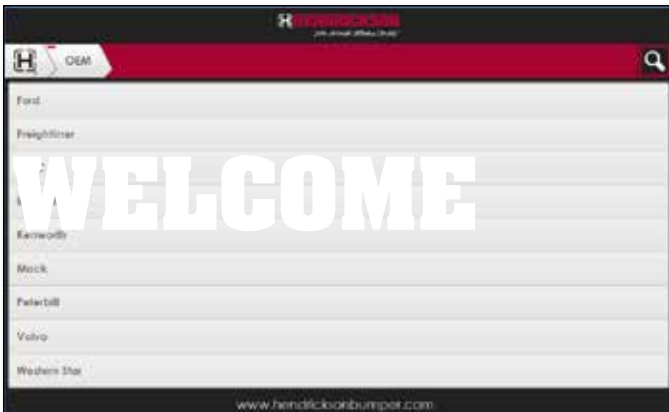

Additional product listings and useful information are only a click away!

Check out our selection and browse our current literature.

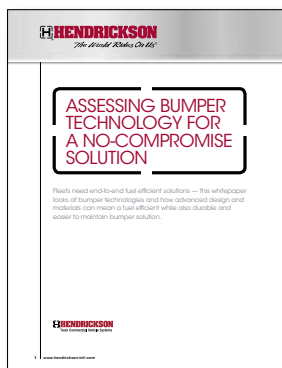

Aerodynamics Study

Fuel Consumption Testing Proves AERO CLAD® Bumper Technology Offers Fuel Efficiency Without Compromise.



Bumper Mobile APP

The Innovative "Truck Bumper Selector Tool" Mobile App is Available for Apple and Android Mobile Phone and Tablet Devices.

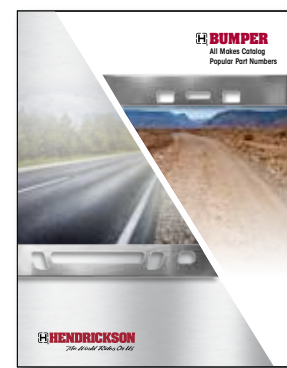

Bumper Product Info

Check Out Our New Bumper All Makes Catalog.

Visit us at www.hendricksonbumper.com

If you can't find what you need, please call Customer Service at 800.356.6737.

GENUINE HENDRICKSON

ALL MAKES PROGRAM

Hendrickson's All Makes Bumper Program offers aftermarket replacement bumpers designed to be a less expensive alternative to the original equipment. The All Makes Program provides parts personnel a wider variety of bumpers than those available through an OEM.

- Comprehensive line of materials and finishes
- New catalog with photos and features / benefits
- Build a bumper configurator available on Hendrickson web site
- Premium grade materials for high quality and finishing
- Free mobile app for more popular bumper selections
- Hundreds of bumper options
- Metal and non-metal bumpers





NOTES

for **ENGINEERED
EFFICIENCY™**

AERO CLAD®

Stainless steel clad aluminum bumpers

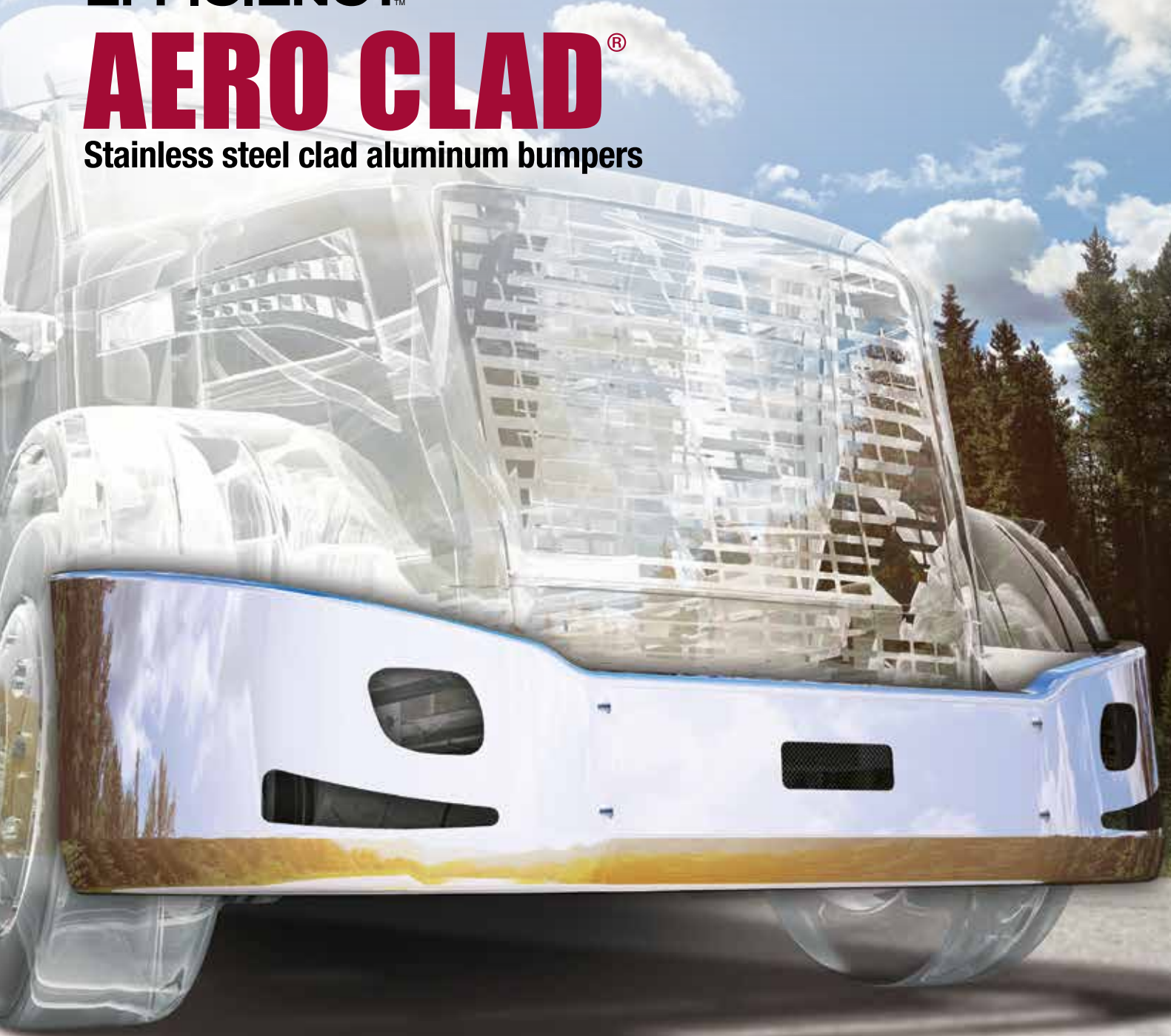

LESS MAINTENANCE

Weight savings, less maintenance, and improved fit and finish compared to chrome bumpers. In addition, AERO CLAD features greater ground clearance while maintaining fuel efficiency and backed by a 5-year warranty*.

*Contact your local Hendrickson representative for complete warranty terms, conditions and limitations.

H HENDRICKSON

www.hendrickson-intl.com/BUMPER

Hendrickson has the most comprehensive product offering of heavy duty truck bumpers for OEM and aftermarket needs. Hendrickson products feature advanced materials specifically designed for bumpers and flexible manufacturing technology to provide customers value through durability, weight reduction and fuel economy.

Call Hendrickson at **800.356.6737** for additional information.



SPECIALTY PRODUCTS - BUMPER AND TRIM

501 Caton Farm Road
Crest Hill, IL 60441 USA
800.356.6737
815.727.4031 • Fax 815.727.9697

www.hendrickson-intl.com